



RFB SERIES

HIGH RELIABILITY FERRITE BEADS



ALL PARTS AVAILABLE WITH GROUP A, B, AND C TESTING

DSCC 03024

Impedance (Ω)	DCR max (Ω)	Current Rating max (A)
30 to 1000	0.01 to 0.60	0.20 to 4

ELECTRICAL SPECIFICATIONS

- **Operating Temperature:** -55°C to $+125^{\circ}\text{C}$
- **Storage Temperature:** -55°C to $+125^{\circ}\text{C}$
- **Impedance tolerances available:**
 $\pm 25\%$, $\pm 20\%$, $\pm 10\%$, $\pm 5\%$
- **Closed, linear magnetic path to avoid crosstalk**
- **Outgassing compliant per ASTM E595**
(TML $<1\%$, CVCM $<0.1\%$)

FEATURES

- **Compact**, low profile, ideal for automatic placement
- **DSCC Approved** (tested per Drawing 03024)
- **Terminations:** Tin-lead (over nickel)
- **Surface Mount Technology**
- **Moisture, Shock and Immersion Resistant**
- **Resistance to Soldering Heat:** 265°C for 10 secs
- Group A/B Data supplied with every shipment
- Group C inspection is optional

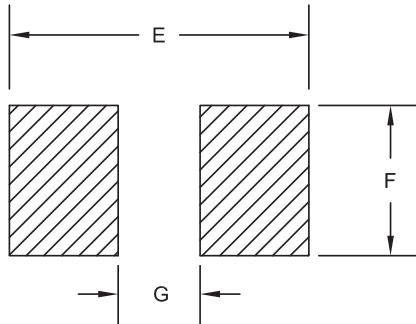
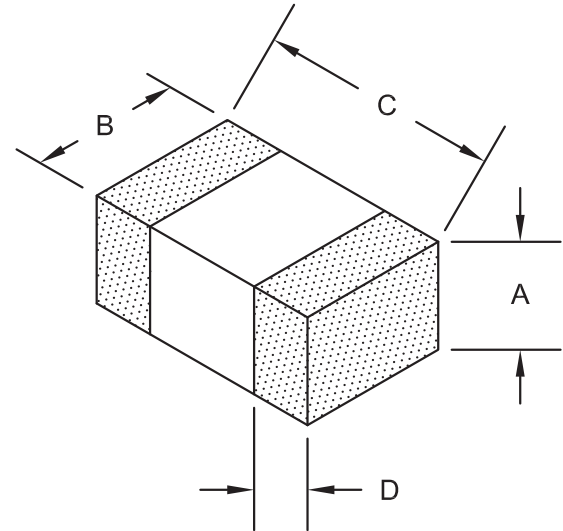
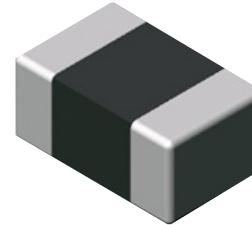

RECOMMENDED PAD LAYOUT

Package	E	F	G
0603	0.102 (2.60)	0.031 (0.80)	0.023 (0.60)
0805	0.118 (3.00)	0.039 (1.00)	0.039 (1.00)
1206	0.173 (4.40)	0.055 (1.40)	0.086 (2.20)

Dimensions are in inches (mm).

Package	A	B	C	D
0603	0.031 ± 0.006 (0.80 ± 0.15)	0.031 ± 0.006 (0.80 ± 0.15)	0.063 ± 0.006 (1.60 ± 0.15)	0.014 ± 0.006 (0.36 ± 0.15)
0805	0.035 ± 0.008 (0.90 ± 0.20)	0.049 ± 0.008 (1.25 ± 0.20)	0.079 ± 0.008 (2.00 ± 0.20)	0.020 ± 0.010 (0.51 ± 0.25)
1206	0.043 ± 0.008 (1.10 ± 0.20)	0.063 ± 0.008 (1.60 ± 0.20)	0.126 ± 0.008 (3.20 ± 0.20)	0.020 ± 0.010 (0.51 ± 0.25)

Dimensions are in inches (mm).





DATA TABLE

Vanguard P/N	DSCC P/N (ref only)	Impedance* (Ω)	DCR max (Ω)	Current Rating max (A)	Package
RFB0603-300**-*	03024-001P	30	0.15	0.50	0603
RFB0603-600**-*	03024-002P	60	0.15	0.50	0603
RFB0603-101**-*	03024-003P	100	0.20	0.40	0603
RFB0603-151**-*	03024-004P	150	0.25	0.40	0603
RFB0603-181**-*	03024-005P	180	0.25	0.40	0603
RFB0603-301**-*	03024-006P	300	0.30	0.20	0603
RFB0603-401**-*	03024-007P	400	0.35	0.20	0603
RFB0603-601**-*	03024-008P	600	0.40	0.20	0603
RFB0603-102**-*	03024-009P	1000	0.60	0.20	0603
RFB0805-300**-*	03024-010P	30	0.02	4.00	0805
RFB0805-500**-*	03024-011P	50	0.08	2.00	0805
RFB0805-600**-*	03024-012P	60	0.15	1.50	0805
RFB0805-700**-*	03024-013P	70	0.15	1.50	0805
RFB0805-101**-*	03024-014P	100	0.20	1.00	0805
RFB0805-121**-*	03024-015P	120	0.20	1.00	0805
RFB0805-151**-*	03024-016P	150	0.20	1.00	0805
RFB0805-221**-*	03024-017P	220	0.20	1.00	0805
RFB0805-331**-*	03024-018P	330	0.25	1.00	0805
RFB0805-471**-*	03024-019P	470	0.25	1.00	0805
RFB0805-601**-*	03024-020P	600	0.30	1.00	0805
RFB0805-102**-*	03024-021P	1000	0.40	1.00	0805
RFB1206-300**-*	03024-022P	30	0.01	4.00	1206
RFB1206-500**-*	03024-023P	50	0.03	3.00	1206
RFB1206-800**-*	03024-024P	80	0.10	1.50	1206
RFB1206-121**-*	03024-025P	120	0.10	1.50	1206
RFB1206-251**-*	03024-026P	250	0.10	1.50	1206
RFB1206-501**-*	03024-027P	500	0.20	1.00	1206
RFB1206-601**-*	03024-028P	600	0.30	1.00	1206

*Impedance measured at 100 MHz

VE PART NUMBER STRUCTURE KEY

EXAMPLE: RFB0603-300KS-3-T

IMPEDANCE (Ω)

The first two digits are significant. The last digit specifies zeros to follow:

300 = 30 Ohms

TOLERANCE (%)

J	± 5
K	± 10
M	± 20
P	± 25

TERMINATION

S	SnPb
---	------

RELIABILITY

2	Group A
3	Group A+B (03024)
4	Group A+B+C
7	Other

PACKAGING (Default Bulk)

B	Bulk
T	Tape and Reel





DATA CURVES

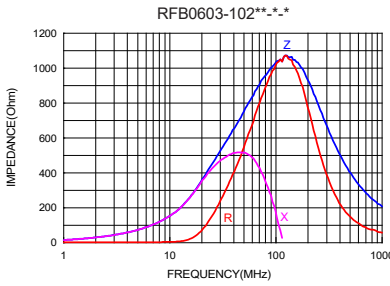
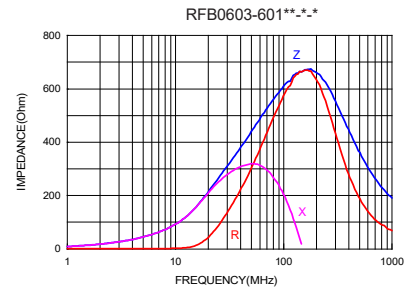
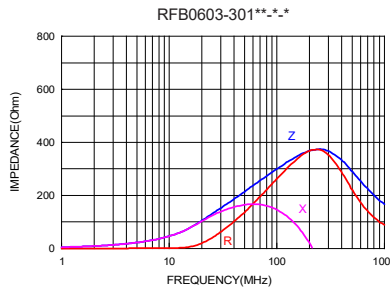
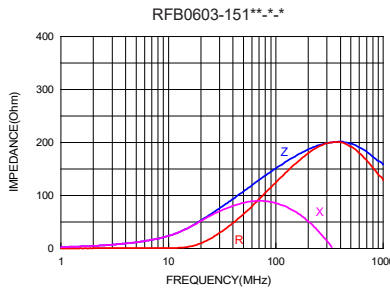
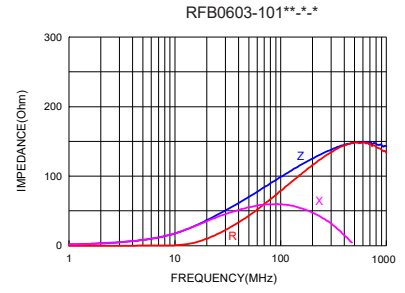
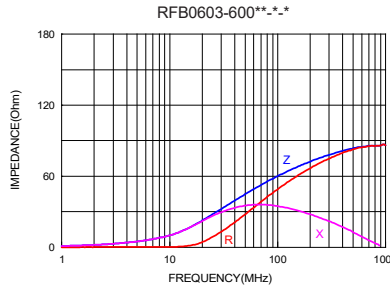
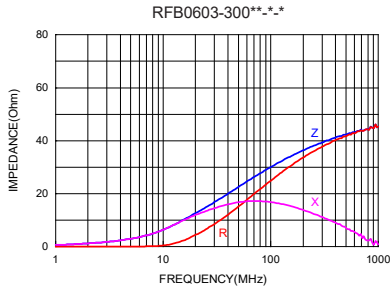

RFB SERIES





DATA CURVES

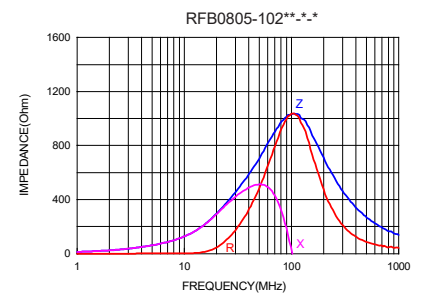
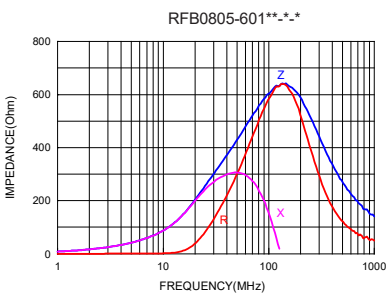
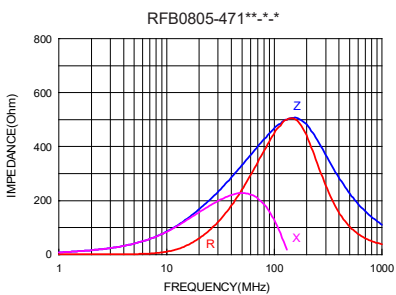
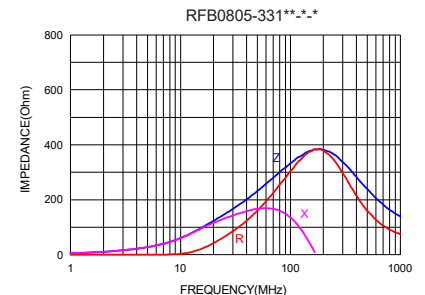
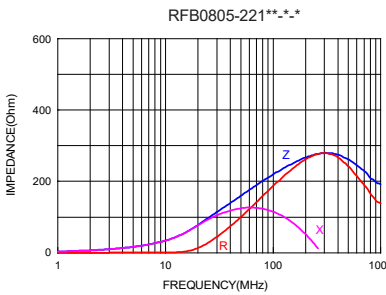
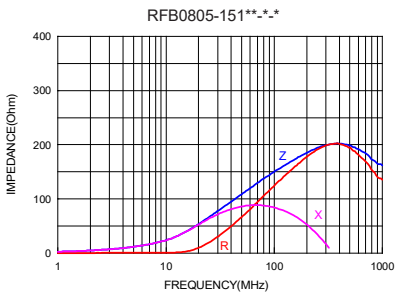
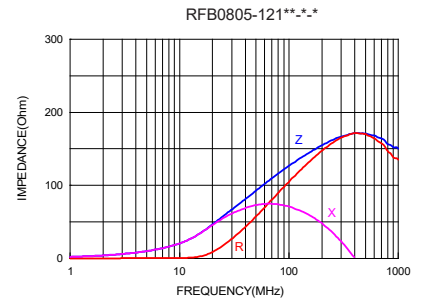
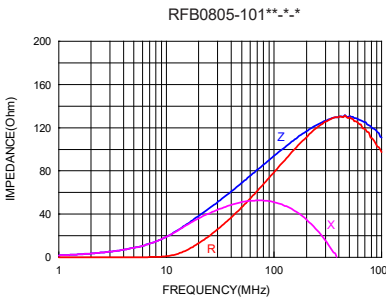
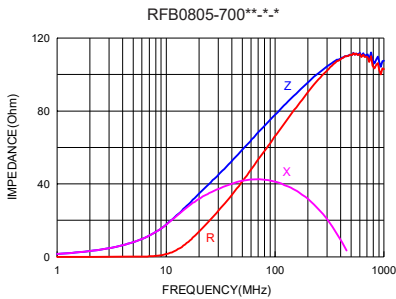
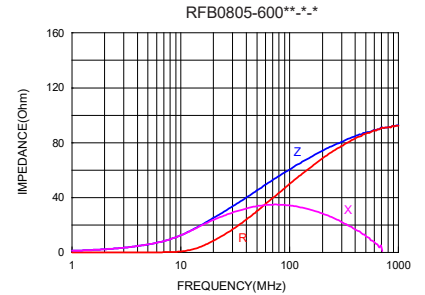
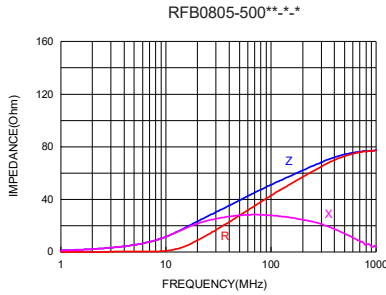
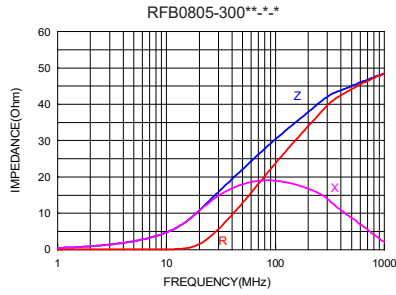

RFB SERIES





DATA CURVES

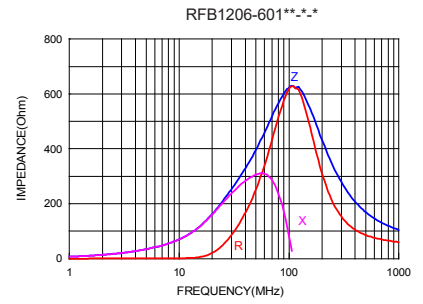
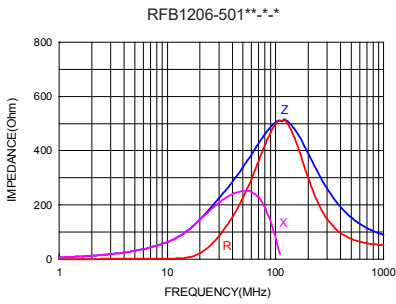
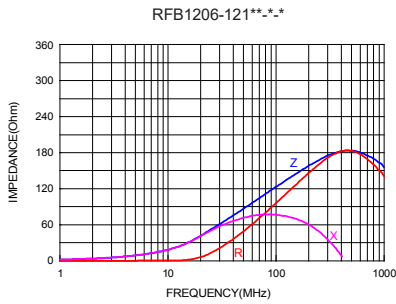
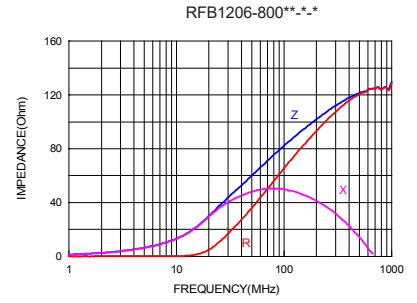
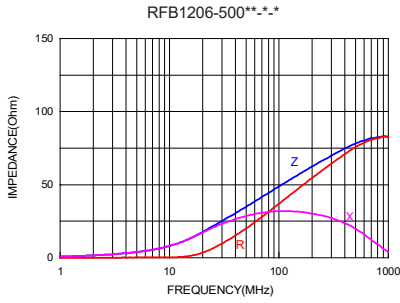
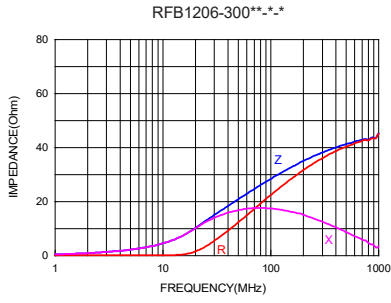

RFB SERIES

